

GATHER Gear Pumps

Non-Pulsation Magnetic Drive Dosing and Process Pumps

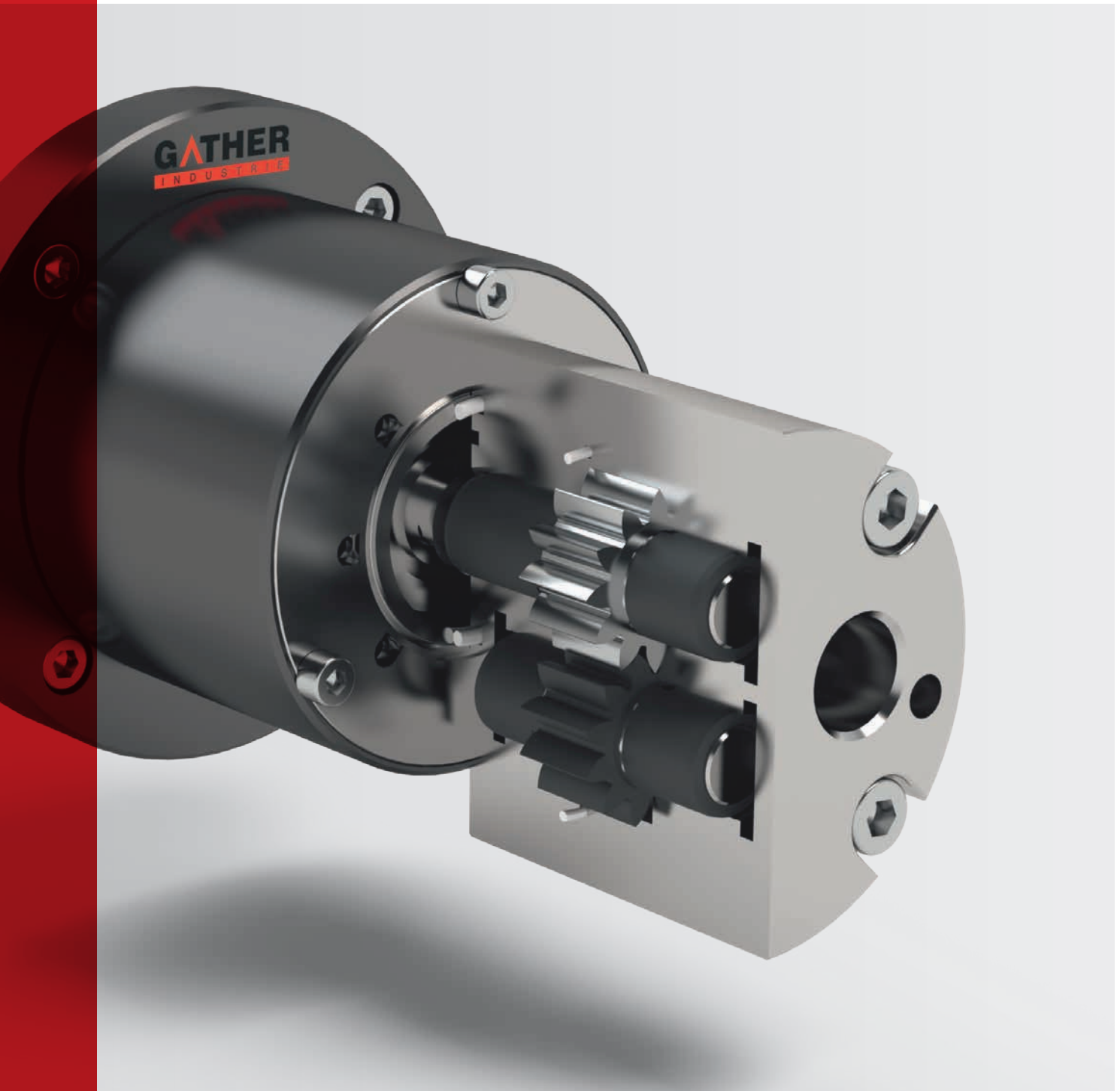

GATHER Gear Pumps

About GATHER Industrie
Page 3

GATHER Gear Pump – Features
Page 4–5

Operating data
Page 6–7

Flow rate characteristics
Page 8–9

Pump Head replacement
Page 10

Special solutions
Page 11

Accessories
Page 12–13

Metering systems
Page 14–15

Drive Technology
Page 16–17

Industries & Applications
Page 18–19

GATHER Contact details
Backpage

www.gather-industrie.com

More than 50 years of experience

In-depth knowledge, broadly diversified solutions

GATHER Industrie GmbH is a medium-sized family business based in Wülfrath, North Rhine-Westphalia – with more than 50 years of experience and a focus on quality and innovation.

As a premium manufacturer of magnetically coupled gear pumps, gear flow meters, metering systems and quick connect couplings for pipes and hoses, the company serves numerous industries and customers, e.g. the chemical, pharmaceutical, medical and food industries. With their expert knowledge in handling non-lubricating liquids, GATHER offers solutions which enable the customer to work with process reliability and durability.

From the “idea to series production”, GATHER Industrie develops not only standard products but also completely new technical solutions according to customer requirements. At the same time we succeed in managing the balancing act from single pieces to the production of small and large series for OEM customers.

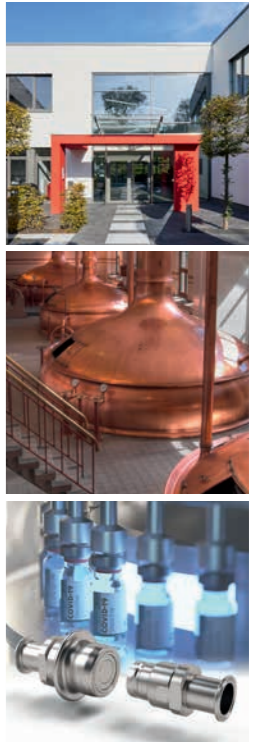

1965
Foundation

50+
Employees

30+
Countries

The GATHER products



Metering and
process pumps



Gear flow meter



Metering systems



Couplings

GATHER Gear pump

Precise pump technology for non-lubricating liquids

The magnetically coupled GATHER Gear pump is a **hermetically sealed dosing and process pump**. In numerous industrial sectors (chemicals, pharmaceuticals, food, medicine, cosmetics, etc.) it is mainly used for the pulsation-free delivery or metering of non-lubricating liquids (e.g. water, salt solutions, acids, alkalis, solvents, etc.).

TECHNICAL DATA

Viscosities	0.1 to 2,000 mPa s (cP)
Temperature range	-200 to +450 °C
Flow rate	20 ml/h to 4,000 l/h
Differential pressure	up to 20 bar

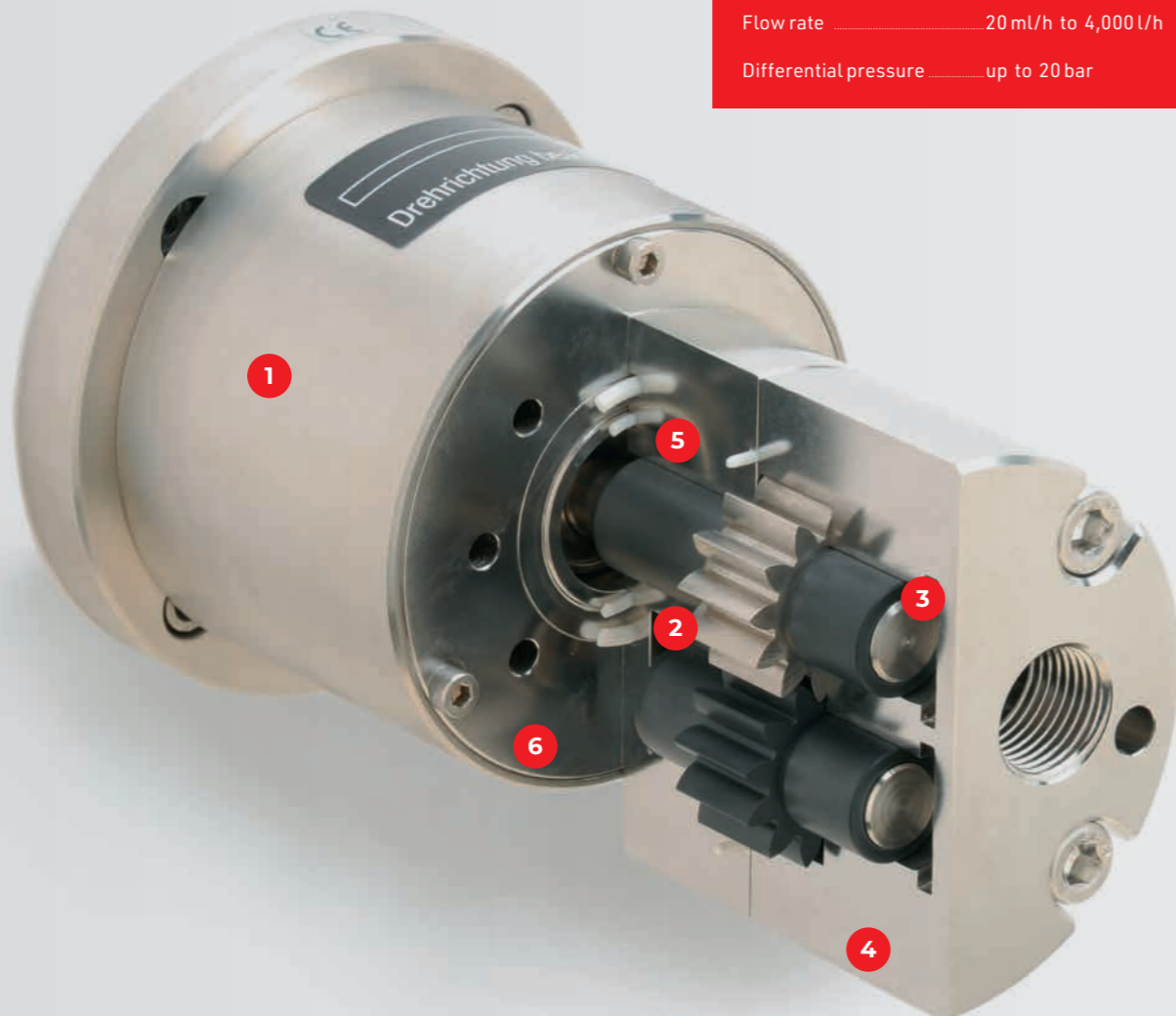

1. Magnetic coupling – hermetically sealed
2. Pulsation-free delivery & dosing – modular system for large operating range
3. Non-lubricating liquids – GATHER materials expertise
4. Cooling magnetic system & slide bearings by internal circulation
5. Robust design and long service life
6. CIP- and SIP capable, if desired

At a glance

1

Magnetic coupling – hermetically sealed

The magnetic coupling ensures contactless torque transmission from the drive to the pump shaft. Unlike mechanical seals, it is not subject to wear and tear and is absolutely maintenance-free. It is hermetically sealed and there is no leakage of the pumped liquid. This is a decisive factor, especially with concentrated, aggressive media and those that are hazardous to health. In addition, it allows easy pump head replacement in practice.

2

Pulsation-free delivery & dosing – modular system for large operating range

Due to the functional principle of the gear pump (displacement pump), a practically pulsation-free, flexibly adjustable flow rate can be attained. The speed-dependent delivery characteristic enables a wide flow rate range with differential pressures up to 20 bar. In three modular series, flow rates within operating ranges between 20 ml and 4,000 l per hour can be achieved.

3

Use of non-lubricating liquids – GATHER materials expertise

Operation with non-lubricating liquids is made possible, amongst other things, by using chemically resistant and high-precision manufactured pump materials. The pump housing and shafts are made of stainless steel, Hastelloy® or titanium, the slide bearings e.g. of carbon or plastic. Depending on the application and

liquid, nickel alloys, PEEK or PTFE (Teflon®) are used for the gears. The gear and slide bearings materials have the required tribological properties for many years of operation.

4

Cooling magnetic system & slide bearings by internal circulation

Internal flushing channels and holes convey a small part of the flow from the delivery side through the slide bearings and back to the suction side. This leads to the internal cooling of the magnetic system and the slide bearings. In addition, the necessary sliding film is created on the slide bearings which ensures a long-lasting function.

5

Robust design and long service life

The use of the magnetic coupling, the internal cooling system, the high precision of the components and the double-volute construction of the pump housing result in a very robust design with an extremely long service life. Depending on the application (liquid), the pumps operate maintenance-free.

6

CIP- and if desired – SIP capability

GATHER pumps are CIP-capable (Cleaning in Place) and, if desired, SIP-capable (Sterilization in Place). Via the existing channels, flushing processes using suitable solvents and liquids can be carried out in the installed state. The SIP version is used very frequently, especially in the pharmaceutical industry.

GATHER Gear pump

The high-precision process pump

The GATHER gear pump is a high-precision process pump. Depending on the series, it handles pumping tasks with a volume flow range of 20 ml/h to 4,000 l/h with a differential pressure up to $\Delta p_{max} = 20$ bar.



Operating data

CHARACTERISTIC	PROPERTY
Materials housing & shafts	Stainless steel, Hastelloy®, titanium and special alloys
Materials gears	Nickel alloy, PEEK, PTFE (Teflon®), etc.
Materials slide bearings	Carbon, PEEK, PTFE (Teflon®), SSiC, etc.
Liquids	Non-lubricating and lubricating liquids
Viscosities	0.1 to 2,000 mPa s (cP)
Flow rate / differential pressure	
Series 1	0.02 up to 360 l/h, up to 20 bar
Series 2	5.0 up to 2,000 l/h, up to 20 bar
Series 3	60 up to 4,000 l/h, up to 14 bar
Temperature	T = -60 up to +300 °C (as special version -200 up to +450°C)
Cleaning	Cleaning in Place (CIP) Sterilization in Place (SIP) upon request
Explosion classes	Zones 1, 2 and 22, temperature classes T1...T6 resp. 100 K below glowing temperature of dust deposits (location 22)

The possibility of operating non-lubricating liquids within the viscosity range from 0.1 to 2,000 mPa s (cP) is attained, amongst other things, by means of different and high-precision processed materials. The pump housing and gear shafts are made of stainless steel, Hastelloy® or titanium, the slide bearings of carbon or plastics such as PEEK or PTFE. The gear wheels are made of a nickel-based alloy, PEEK or PTFE (Teflon®) and can be freely combined with each other. The materials used for gear wheel and slide bearings all have **excellent tribological properties**.

Internal rinsing channels and holes direct a small portion of the flow rate from the discharge side through the slide bearings back to the suction side. This results in the internal cooling of the magnet system and the slide bearings. Additionally, the necessary sliding film is produced on the slide bearings which ensures a durable function.

If aqueous liquids are delivered, there will be no dead spaces in the pump. This effect can be exploited for cleaning in place (**CIP – Cleaning in Place**) by means of a solvent or cleaning agent. This is also the basis for a SIP pump (**SIP – Sterilization in Place**) which can be sterilized in the installed state and is mainly used in the pharmaceutical industry.

With the right pump design, selection of materials and design of the drive unit we find the solution which enables our customers to work with process reliability. This also includes the design as a complete system with corresponding control circuit and accessories according to the customer's specifications. Special solutions are our speciality. This also involves the use in potentially explosive atmospheres **in compliance with the ATEX directives**.



Flow rate characteristics

Series 1



The smallest of product series 1
DRIP Industrial Dosing Pump



Series 1:
The classic for demanding conveying and dosing task

Series 1 – DRIP

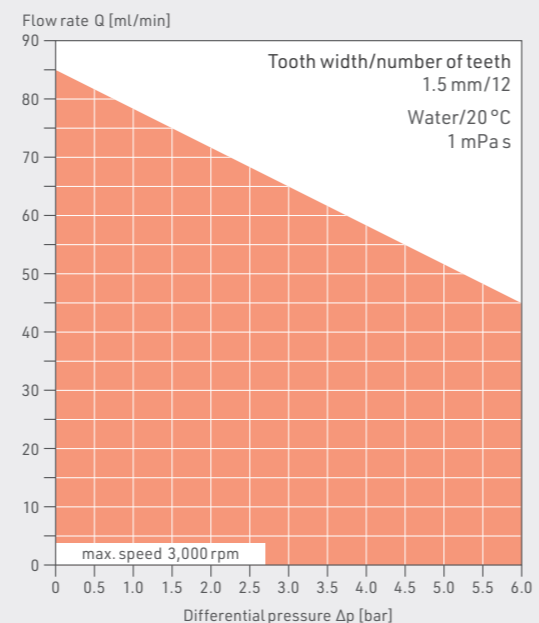

Series 1

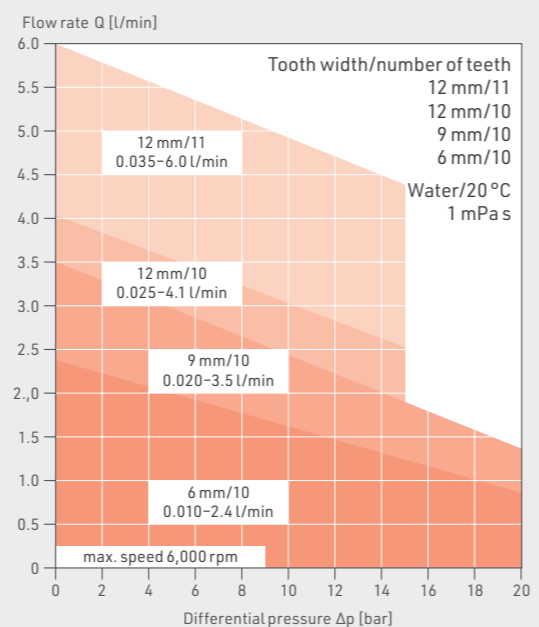
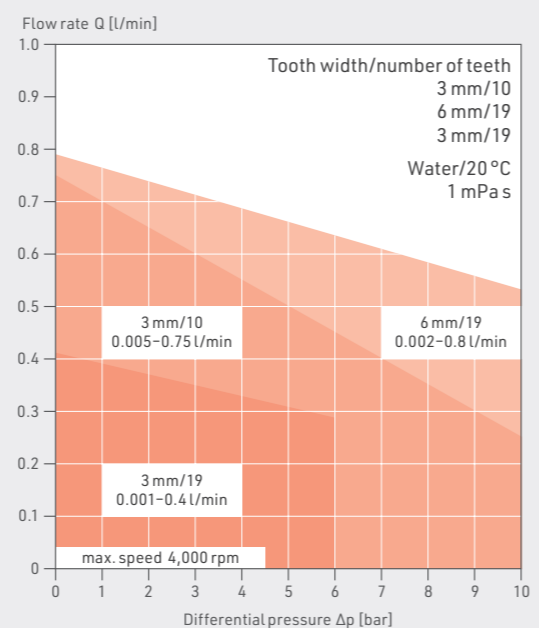

Series 2

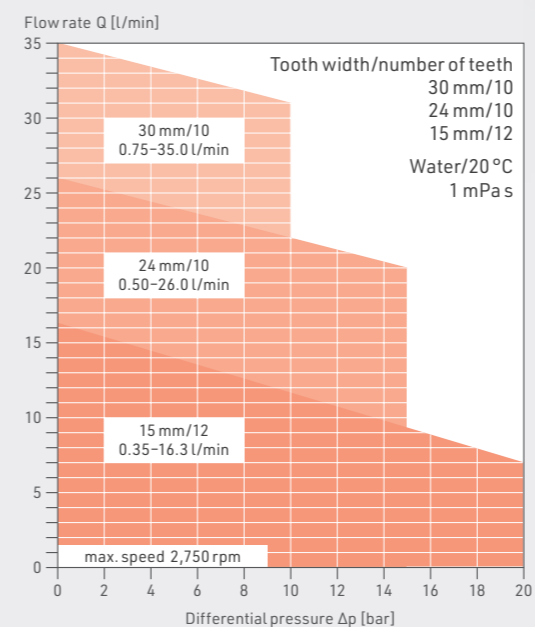
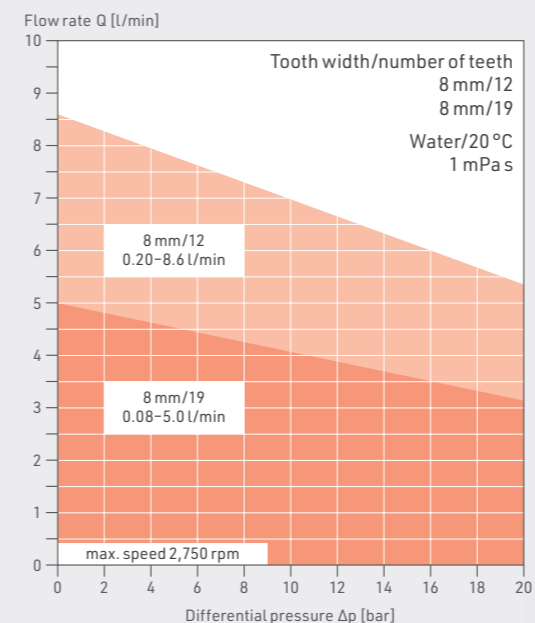

Series 3

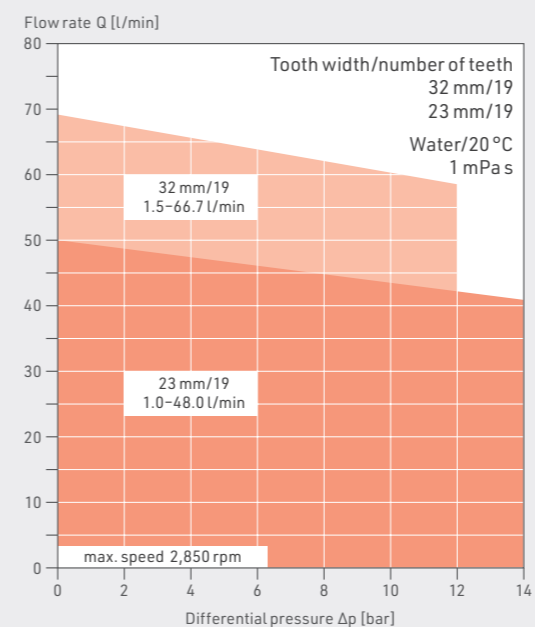

Series 2



Series 2:
The robust process pump for universal applications

Series 3



The largest:
Series 3 enables flow rates of up to 4,000 l/h

GATHER Gear pump

Effortless Pump Head Replacement

Replacing the pump head for maintenance or replacement purposes is very easy:

- 1 Loosen the three screws on the pump carrier (bracket)
- 2 Turn the pump head
- 3 Pull off the pump head

To re-attach the pump head proceed in reverse order!



Attention

Be careful with the strong samarium-cobalt magnets!
Please observe our mounting instructions!

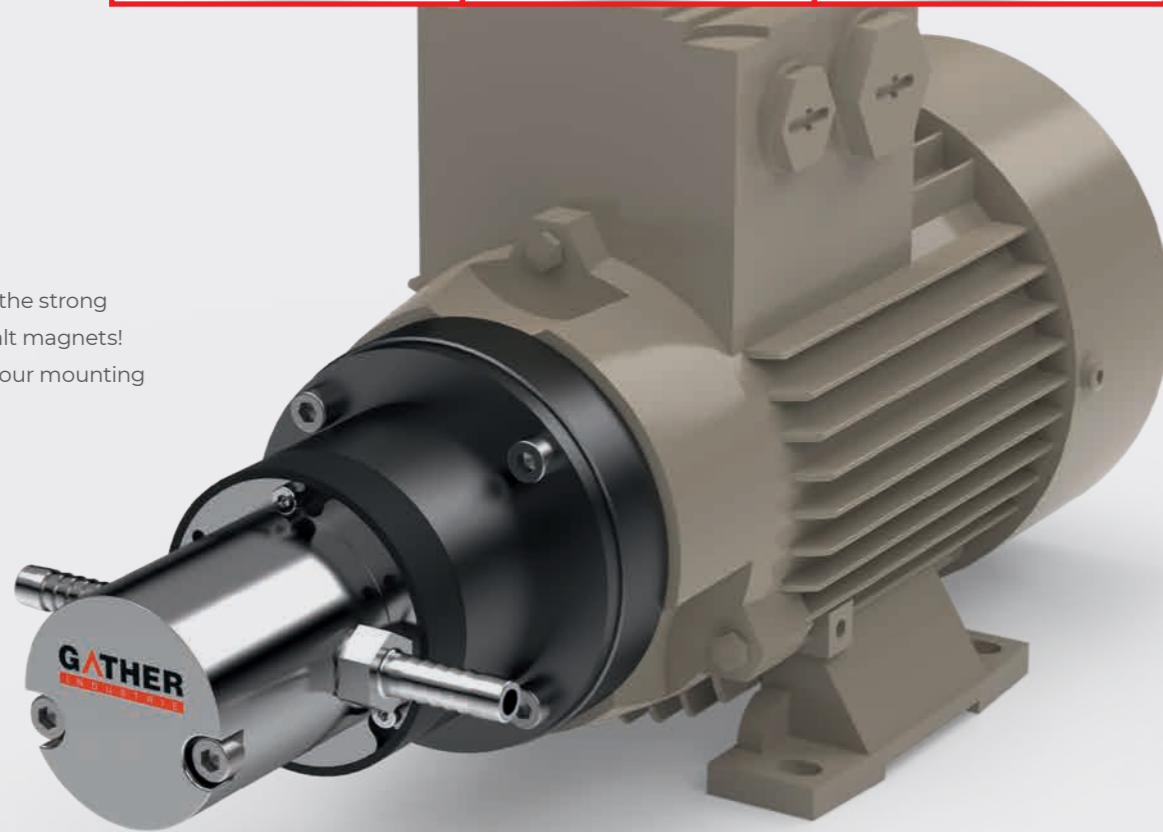

GATHER Special solutions

Special solution for pharmaceutical application



The SIP version was the first in-line sterilisable gear pump and has proven itself since 1998 in many pharmaceutical applications where the piping system has to be sterilised in-line with steam.

It has the same properties as the standard series of GATHER gear pumps and can additionally be sterilised with steam.

Characteristics

- + pharmaceutically compliant connections (e.g. TriClamps or dairy pipe)
- + hygiene class H3 (Ra ≤ 0,8 µm)
- + steam sterilisation at +135 °C

Robust up to 300 bar and 450 °C



It has the same properties as the standard series of GATHER series 2 magnetically coupled pumps and has been modified with regard to system pressure and maximum operating temperature.

Characteristics

- + maximum operating temperature +450 °C
- + maximum system pressure 300 bar abs.
- + special magnet system
- + special slide bearings materials

GATHER Accessories

Use in the high temperature range

The **GATHER heating jacket system** ensures an even heating of the pump head by the flow of a heating fluid. The heating jacket can be easily plugged and installed onto the pump head. Due to the appropriate design and material selection – especially in the area of the magnet cup and the seals – the stainless steel pump can be used up to a system pressure of 300 bar and at a simultaneous temperature of +450°C.

Specification

- + heating temperature up to +450 °C
- + pressure in the heating jacket up to 20 bar
- + housing stainless steel 1.4571
- + heating / cooling fluid: brine, steam, thermal oil, etc.
- + heating connections G 1/4 female thread



TECHNICAL DATA	
Material	Stainless steel (1.4571)
Temperature range	T = -15 up to +450 °C
Seals	FFKM (FDA-compliant)



Inline filter “Mini”

The **GATHER filter** with drain plug is an universal filter designed even for extreme process conditions. Operating temperatures of up to 350°C at system pressures of up to 500 bar are possible. The stainless steel and Hastelloy® versions qualify this filter for use with aggressive liquids. Through using “pleated” filter elements, a compact design with a large filter surface is created, which causes only low pressure losses. The filter is optimally suited for use as a pre-filter in suction lines.



TECHNICAL DATA	
Max system pressure	500 bar
Max temperature	+350 °C
Standard fineness	10 µm
Housing	Stainless steel: Nitronic® 60 / 1.4404 Alternative: Hastelloy® C-276
Filter	Stainless steel: 1.4401 Alternative: Hastelloy® C-22®
Connection	G 3/8 female thread



GATHER Accessories

Overflow valves

The **GATHER overflow valves** for liquids, gases and vapours are simply designed and compact pressure limiters which offer accurate inlet pressure adjustment with easy installation and maintenance. In operation, the inlet pressure is in balance with the spring-loaded valve as soon as the preset opening pressure (in the pipeline) is reached and exceeded. The preload of the valve spring – and thus the opening pressure – can easily be adjusted from the outside. As connections, standard pipe fittings or individual connections according to customer specifications are available.



TECHNICAL DATA	
Material	Stainless steel (1.4571)
Temperature range	T = -15 up to +300 °C
Seals	FFKM (FDA-compliant)



Advantages

- + TÜV-certified
- + compliant with the German "TA-Luft"
- + FDA compliant
- + ATEX compliant
- + compact straight-line construction
- + freely selectable optimal installation location
- + low pressure loss (adjustment range 1:35)

Non-return valves

GATHER Non-return valves for liquids, gases and vapours

The proven accessories for our magnetically coupled pumps

- + ensure constant flow resistance
- + used under vacuum in pump applications
- + available in stainless steel or Hastelloy®

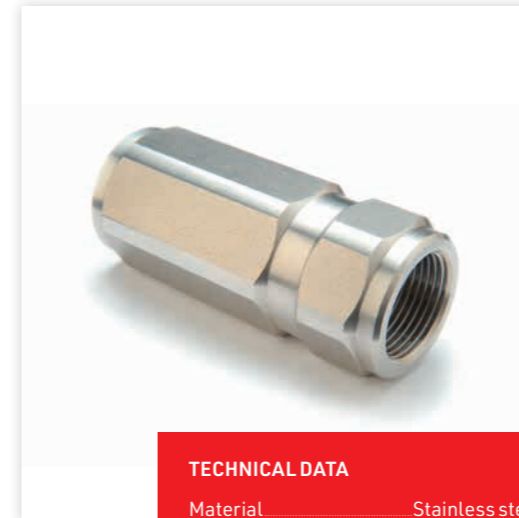

TECHNICAL DATA	
Material	Stainless steel (1.4571)
Seals	FKM (Viton®) (-20 up to +200°C) EPDM (-40 up to +150°C)
Response pressure	1,0 barg (± 10%)



GATHER Metering systems

Overview – Metering systems according to customer specifications

GATHER also supplies complete metering systems as solution according to ATEX for zone 1 or 2. This includes the conceptual design and selection of all components of the pump control loop according to customer specifications.



Possible conceptual designs

- + both "stand-alone systems" and integration into existing process systems
- + control electronics in pressure-capsulated design according to EN 60079-1
- + ATEX zone 1 and 2
- + integration of safety monitoring, e.g. dry-running, overpressure, overheating, etc.
- + Universal controller (GATHER Metering box 5000) for continuous metering or batch filling
- + compact Metering station GDS ("Plug and Play")
- + modular rack design according to customer specifications
- + engineering advice on site



GATHER Metering station GDS

Pump, controlling, sensor technology – All in one station

Proven pump technology, integrated controlling and regulation as well as flow and pressure measurement in one station. This is what GATHER delivers in the new compact GDS metering station. All components are integrated in a stainless steel housing to save space. As a "plug-and-play solution", the lightweight and mobile metering station is suitable for many applications. With the integrated control software and the user-friendly interface, any metering and conveying task can be implemented quickly and easily.



GATHER Metering box 5000

The universal controller for all pump and control loops

GATHER's Metering box 5000 with integrated, universal PLC enables exact conveying, metering or filling at the touch of a button. It is suitable for all applications where pumps are operated in a loop system.



Modular rack design

Development, assembly and manufacturing from a single source

With decades of experience in the chemical, pharmaceutical, medical and food industries, we can offer complete system solutions from a single source and supply individually modular systems. These solutions include transfer, measuring and monitoring as well as process control with our GATHER Metering box 5000.

- + development, assembly and manufacturing from a single source
- + grooved profile systems in stainless steel or aluminium
- + modularly expandable
- + customized welded constructions in stainless steel design
- + engineering advice on site



GATHER Drive technology

Wide range of drives for all sectors and applications

A wide range of low-voltage motors is available for our pumps, suitable for all industries and applications. Our standard motors in the IP55 version are equipped with PTC thermistors and are available from stock at short notice. They meet all international and national efficiency regulations. But also customized solutions according to individual requirements are our business. Our experts will find the right drive for your task as well, including design and control.

Selection of different variants and applications:

- + nominal voltages 3 x 230 V resp. 3 x 230 – 690 V 50/60 Hz
- + frequency converter operation up to 100 Hz (also available as compact drive)
- + pole numbers from 2 to 8 with different speed ranges
- + protection class IP55 (standard), IP56 or IP65 are also available on request
- + certification for UL/CSA, EAC
- + explosion protection for zones 1, 2 and 22 according to the ATEX directive
- + certification for IECEx, EAC EX, CCC, PESO, KOSHA and HAZLOC
- + control gears with control range from 10 to 3,000 rpm also ATEX-compliant for zones 1, 2 and 22
- + all RAL colours available; special coatings according to customer requirements (e.g. for special environmental conditions)
- + stationary heaters; tropical insulation

In addition to three-phase motors, we also have a wide range of different variable-speed DC servo motors (12 V, 24 V and 48 V) as well as special motors according to customer specifications. We would be happy to advise you on the right choice of drive.



Drives and Speed Control

Examples – Series 1



Three-phase motor for ex-proof area

- + three-phase motor (IP 55, flame-proof enclosure) for hazardous areas, controlled via frequency converter
- + n = 200–6,000 rpm, external control capability
- + 1 x 230 V, 50/60 Hz



Laboratory motor

- + speed control for laboratory service
- + n = 200–5,000 rpm, 4-digit indication, external control capability (RS232 etc.)

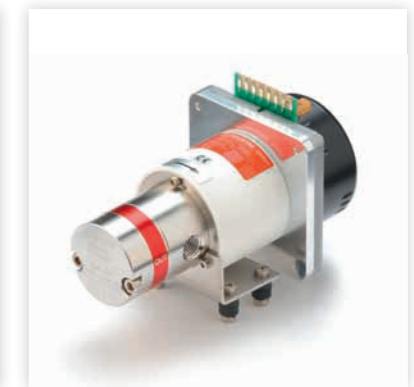

DC motor

- + brushless DC motor (IP 00) of compact design, ideal for integration into miniature units
- + n = 350–3,500 rpm, external control capability
- + 0–10 V, supply voltage 24 V
- + favorable price/performance ratio

Examples – Series 2



Three-phase drive for hazardous areas

- + constant-speed three-phase motor (IP 55, increased safety) for hazardous areas, constant speed rates available on request
- + n = 2,750 rpm
- + n = 1,350 rpm
- + n = 900 rpm
- + 3 x 230/400 V, 50 Hz

Aside from the above described drives, we offer mechanical positioning gears, helical geared motors, servomotors and other special-design motors tailored to individual pump application needs.

Explosion proof classes
 ATEX: Zones 1, 2 and 22
 Temperature classes T1...T6 or 100 K below the glowing temperature of dust (zone 22)

Industries & Applications

Use in all sectors of industry – GATHER has the solution!

GATHER products are used in almost all sectors of industry. Wherever precise delivering, measuring, dosing or coupling of fluids matters. Whether lubricating or non-lubricating, whether low-viscosity or viscous, whether pump, flow meter, complete system or coupling.

Our engineering is your solution!



Flow meter



Metering systems

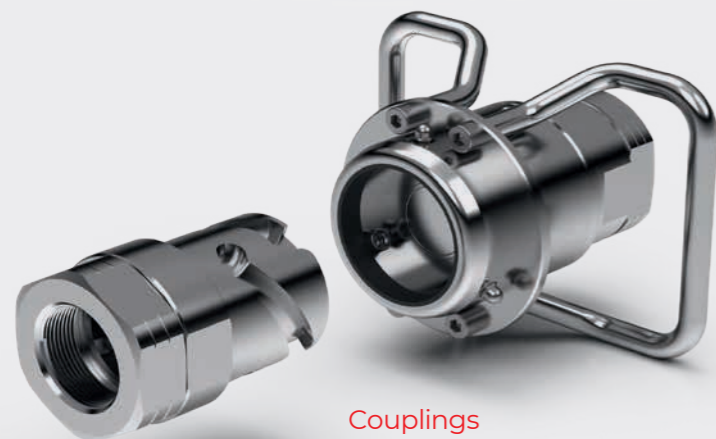

Couplings



Metering and process pumps

Liquids for every industry and application



Chemical and Process Engineering

- + Water
- + Saline Solutions
- + Caustic Soda
- + Sulfuric Acid
- + Hydrochloric Acid
- + Formic Acid
- + Nitric Acid
- + Phosphoric Acid
- + Alcohols (Methanol, Ethanol, Toluene, Xylene, etc.)
- + Tetrahydrofuran (THF)
- + Resins
- + Hydrocarbons
- + Barrier fluids for Double-Action Mech. Seals GLRD



Pharmaceutical and Cosmetics Industry

- + Nutrient solutions
- + Dyes
- + Perfumes
- + Hydrogen peroxide/H₂O₂
- + Vinegar essence
- + Enzymes
- + Various alkalis and acids
- + Cell fluids
- + Silicone oil



Medical Technology

- + Water
- + Active ingredients
- + Vaccines
- + Adhesives



Food Industry

- + Vegetable oils
- + Cooking fats
- + Yeast solutions
- + Fish oils
- + Nitric acid
- + Citric acid
- + Caustic sodas
- + Sulfuric acid
- + Tetrahop
- + Isohop
- + Caramel
- + Essences



Water Management

- + Caustic Soda
- + Sodium hypochlorite
- + Hydrochloric acid
- + Iron (II) Chloride
- + Iron (III) Chloride

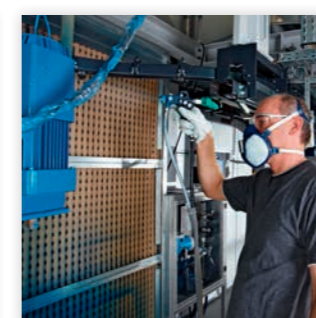

Automotive Industry

- + Paints and varnishes
- + Petrol
- + Diesel
- + Kerosene
- + Additives for fuels
- + Cooling liquids

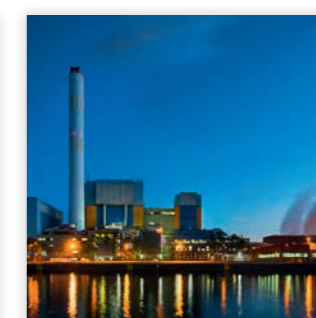

Steel Industry and Power Plants

- + Ammonia water
- + Urea (Adblue)
- + Cooling liquids
- + Water



Oil Industry

- + Crude oil
- + Petrols
- + Kerosene
- + Diesel
- + Solvent Yellow 124
- + Thermal oil
- + Various additives

GATHER Industrie GmbH

Lise-Meitner-Straße 4
42489 Wülfrath
GERMANY
Phone +49 2058 89381-0

Pump Technology

Filters and Valves

Phone +49 2058 89381-23
Fax +49 2058 89381-50
pump@gather-industrie.com

Coupling Technology

Phone +49 2058 89381-23
Fax +49 2058 89381-50
coupling@gather-industrie.com

Measurement and Control Technology

Phone +49 2058 89381-23
Fax +49 2058 89381-50
measurementtechnology@
gather-industrie.com



www.gather-industrie.com

Why GATHER pumps?

With the right design of the pump as well as the selection of materials and seals according to the liquid and application, we offer our customers process-reliable and durable solutions. The pump bodies of the centrifugal and gear pumps and the shafts are made of stainless steel, Hastelloy® or titanium, the sleeve bearings of carbon or plastics such as PEEK or PTFE.

In the case of gear pumps, the gears are made of a nickel-based alloy, PEEK or PTFE (Teflon®) and can be freely combined with each other. The materials used for the gear wheel, slide bearing and shaft all have excellent tribological properties. The use of the magnet coupling, the internal cooling system together with the high precision of all components result in a very robust design with an extremely long service life. Depending on the application (liquid), the pumps operate maintenance-free.

GATHER is not only a component manufacturer, but also a solution provider for design as a complete system according to customer specifications with the corresponding control loop and accessories. Special solutions are our speciality as well. This also includes the use in potentially explosive atmospheres in compliance with the ATEX directives. Our sales engineers and partners have extensive expertise and application knowledge and are your contacts. Either on-site at your premises or at our head office in Wülfrath.